

# Specification

LLS-L series

BH5470



# BH5470

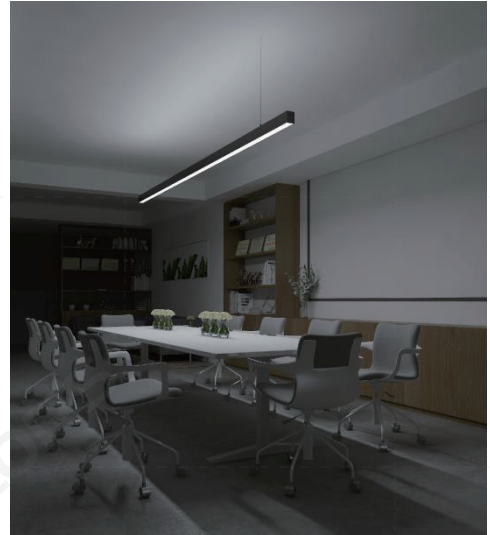
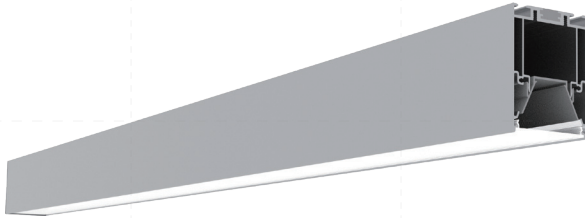

## Features

- Innovative buckle plug, no light leakage
- Carrier tight fit design carrier buckle extremely convenient for installation and maintenance
- Designed in anti-leaky block piece, perfect details
- Free to collocation ordinary PC diffuser, flexible diffuser, anti-glare flexible diffuser, black diffuser, aluminum diffuser
- Provide standard extenders, customizable interconnected corners
- Built-in linear power supply, invisible and beautiful
- Various installation ways: pendant, recessed, surface

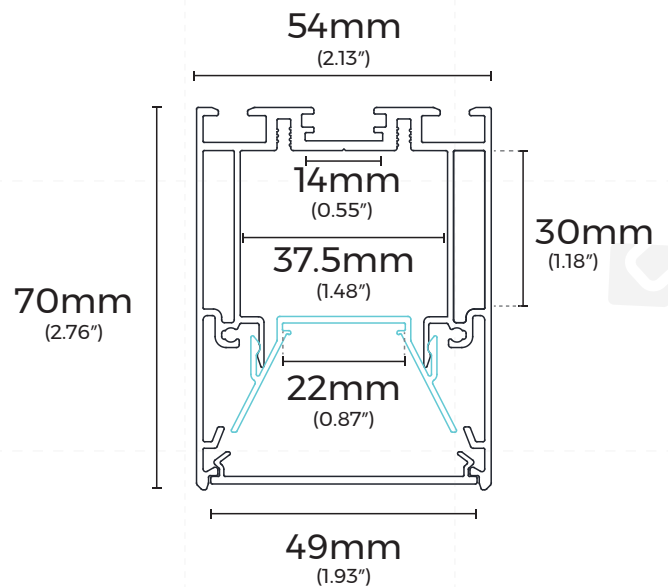

## Details

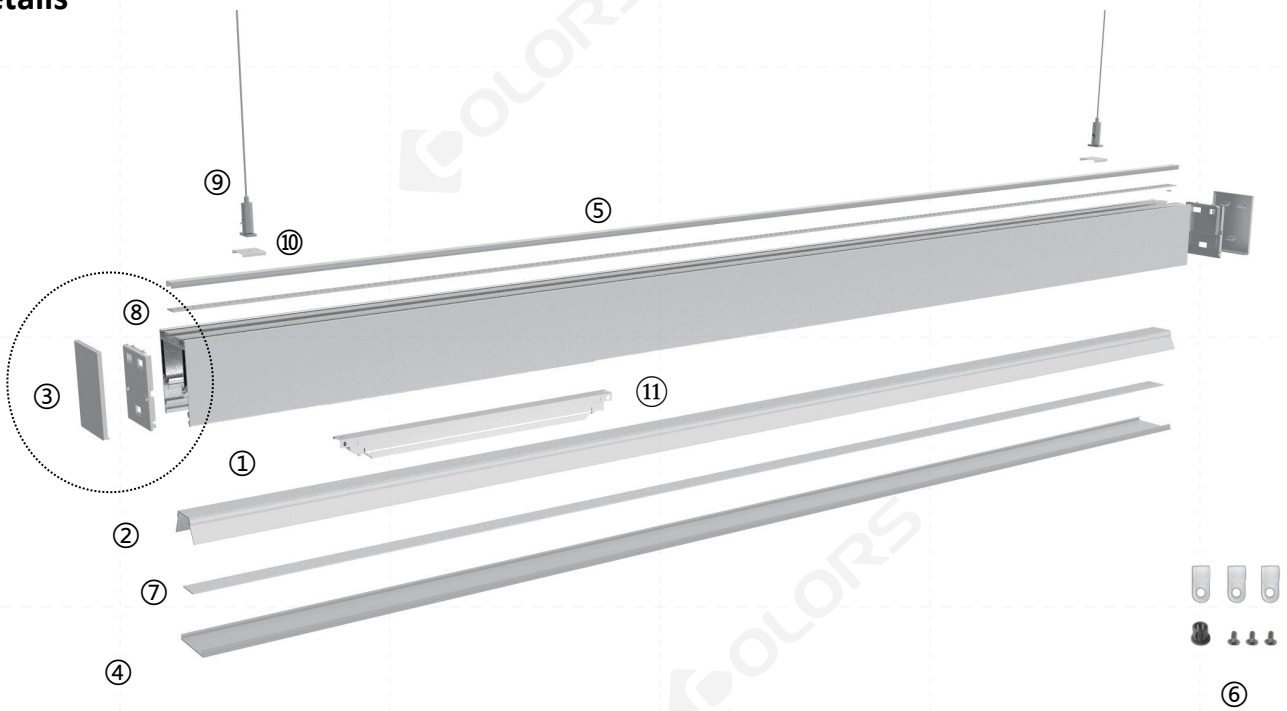











## Standard Configuration

Picture	Item	Parameter
	①Profile /②Carrier:	Profile weight : 3.6kg/2.5m Size : L2500*W54*H70mm Material : AL6063-T5 Surface processing : Anodizing
	④Cover	Type: Frosted diffuser Material: PC ; Light transmittance: 80% Size : L2500*W48.8*H5.9mm PC Feature: The diffuser will extend (shrink) 0.8mm/m when the temperature raises (drops) 10°C.
	⑤Cover(up ward)	Type: Frosted diffuser Material: PC ; Light transmittance: 80% Size : L2500*W11*H5.0mm PC Feature: The diffuser will extend (shrink) 0.8mm/m when the temperature raises (drops) 10°C.
	③End cap	Model : EC-BS5470FSS Size : L54*W70*H5.4mm
	⑥Cable clip	Model : BG-02





## Optional Accessories

Picture	Item	Parameter
	⑦ Flexible strip DL8280-24V-18mm (lighting downward)	Material: FPC,CCT:2700/3000/3500/4000/5000/6500K; CRI > 80/>90; Voltage: 24V; Power: 25W/m; Lumen: 3400Lm/m; Width: 18mm; Minimum cutting unit: 14LEDs/50mm;
	⑧ Flexible strip DL8160-24V-8mm (lighting upward)	Material: FPC, CCT : 2700/3000/3500/4000/5000/6500K; CRI > 80/>90; Voltage: 24V; Power: 15W/m; Lumen: 2150Lm/m; Width: 8mm; Minimum cutting unit: 8LEDs/50mm;
	⑨ Pendant cable with junction box	Model: PY-DXXX Junction box L80*W80*H30mm
	⑨ Pendant cable without junction box	Model: PN-DXX Steel cable D1.5*2000/4000mm
	⑩ clip	Model: CP-16
	Pendant rod	Model: PG-IA2 Size: 1-2m
	Reflective paper	Model: BG-23 Size: L15000*W19*H0.188mm
	Integrated track cabling accessories	Dimming: CM-03; CM-06 No dimming: CM-04; CM-05
	⑪ Power supply	Model: BN-V24-060P-V1 Size: L329*W30*H17mm
	Whole lamp splice	Model: EX-39-S Size: L150*W37.2*H29.8mm
	External splicing part of the whole lamp	Model: EX-41-S Size: L110*W15.5*H11.7mm

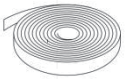

## Cover type

Picture	Item	Parameter
	②cover	Type: Diffuse flexible mask Material: PC + silica gel; Transparency: 70 % Size: L50000*W48.7*H5.5mm
	②cover	Type: Night mask Material: PC; Transparency: 11 % Size: L2500*W48.8*H5.6mm

## Corners

L-type corner (L90- BH5470)



Al6063-T5  
L150\*W150\*H70mm

T-type corner(T90- BH5470)

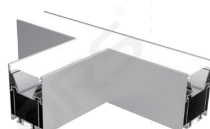

Al6063-T5  
L300\*W177\*H70mm

X-type corner(X90-BH5470)



Al6063-T5  
L300\*W300\*H70mm

\* The corners without light source.

## Optical Parameter

DL8280-24V-18mm/DL8160-24V-8mm light source, frosted diffuser

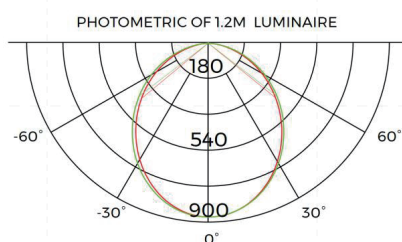

1m	312.88773lx	243.14cm
2m	78.202193lx	486.29cm
3m	34.759748lx	729.43cm
5m	12.513509lx	1215.71cm
7m	6.3841790lx	1966.01cm
Height	Eavg,Emax	Angle:101.12deg
		Diameter



**Package**

COLORS Individual :

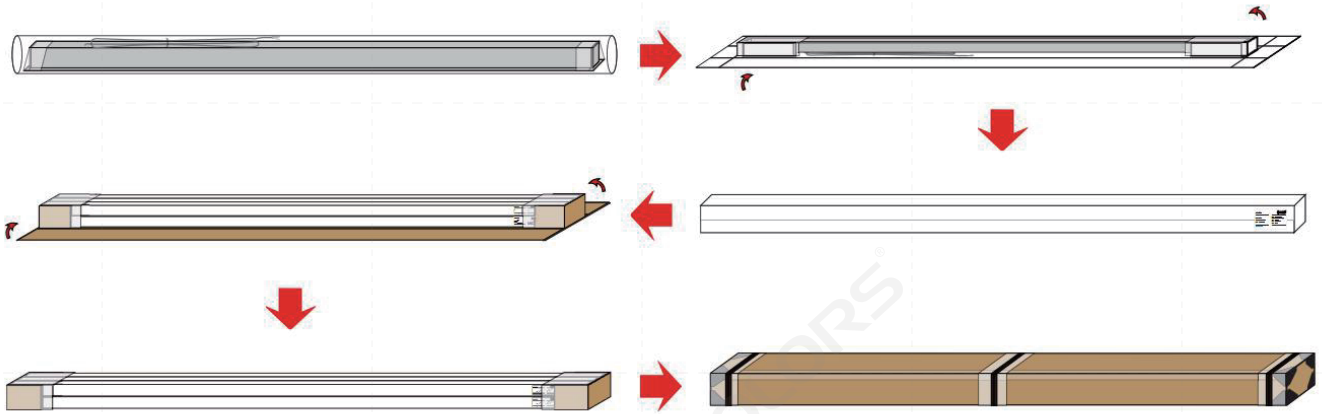

COLORS Whole :

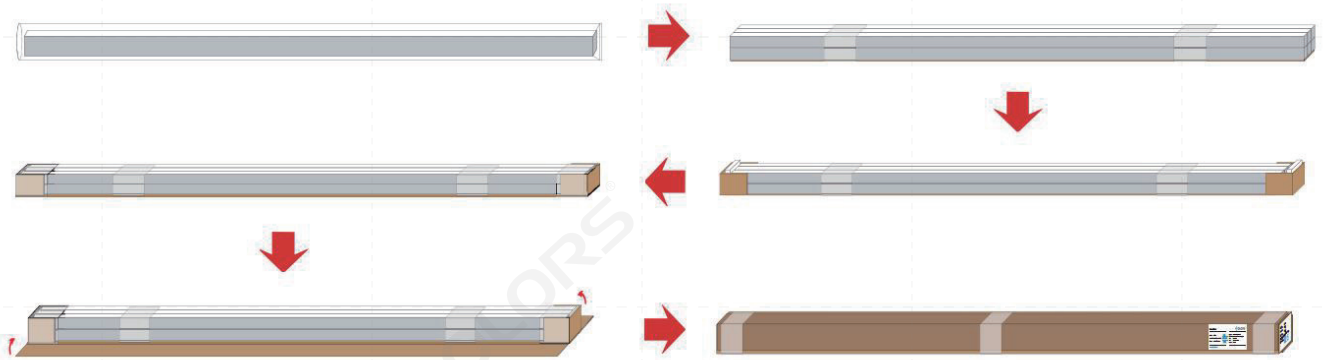

Components	Packaging material	Size(mm)	NW(kg)	GW(kg)	Content
Single piece	Paper box	2560*99*65mm	4.62	5.12	1pcs/box
COLORS Individual	Paper box	2580*228*219mm	27.72	30.72	6pcs/box
COLORS Whole	Paper box	2580*192*168mm	27.72	30.72	6pcs/box

